

Model MDS-5T-□S Inductive Sensor

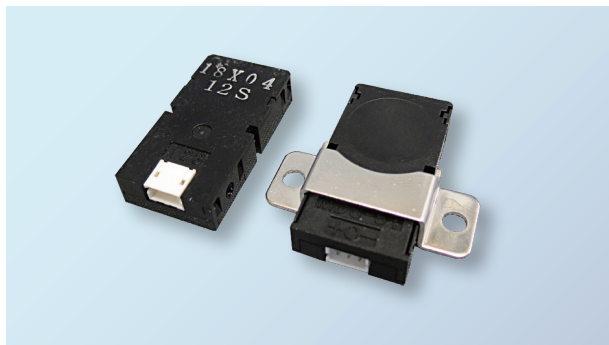

□Model List

Power Supply Voltage	Standard frequency	Different frequency
5V DC	MDS-5T-5S	MDS-5T-5SB
12V DC	MDS-5T-12S	MDS-5T-12SB

Application

- Iron sheet detection
- Positioning of the processing machines
- Metal detection in a narrow space
- Position detection of the moving table and metal pallets

Features

- Small flat inductive sensor with a detection surface of 16 mm, a case of 6 mm in thickness, and a detection distance of 5 mm (Upper surface detection type).
- Equipped with a small connector for simple mounting and wiring.
- The MDS-5T-□S features a keyway on the case side for an easy mounting in one touch. You may also use the mounting bracket (Sold separately).

Rating / Performance

Model	MDS-5T-5S	MDS-5T-12S
Detection Surface	Upper side detection	
Detection Distance	5 mm ±10%	
Hysteresis	15% or less of the detection distance	
Set Distance	0 to 4.0 mm	
Standard Detection Target	Iron sheet of 20 × 20 mm and 1 mm in thickness	
Power Supply Voltage	5 V DC (Operating voltage range : 4.5 V to 5.5 V DC)	12 V to 24 V DC (Operating voltage range : 10.8 V to 26.4 V DC)
Current Consumption	2 mA DC or less	6 mA DC or less
Output	30 V DC, 50 mA DC or less NPN transistor open collector	
Output Residual Voltage	1 V DC or less (Load current 50 mA DC)	
Operation Status	Normally open (ON output when detecting)	
Response Frequency	500 Hz or more	
Temperature Range	-20 to 60 °C (-25 to 65 °C storage temperature range)(Without dew condensation or icing)	
Humidity Range	35 to 85% RH (35 to 85% RH storage humidity range)(Without dew condensation)	
Dielectric Strength	500 V AC for 1minute (Between the live part and case)	
Insulation Resistance	50 MΩ or more at 500 V DC megger (Between the live part and case)	
Vibration Resistance	10 to 55 Hz, 1.5 mm double amplitude in X, Y and Z directions for 2 hours each (at power off)	
Shock Resistance	200 m/s ² (Approx. 20 G) in X, Y and Z directions 3 times each (at power off)	
Protection	IP50	
Case Material	ABS	
Connector	Connector: S3B-ZR (3-pin) (from J.S.T. Mfg. Co., Ltd.) [Connections] Housing: ZHR-3, Contact: SZH-002T-P0.5 (from J.S.T. Mfg. Co., Ltd.)	
Weight	Approx. 4 g	
Options (Sold Separately)	Mounting bracket : PMS-5TS, Connector harness : SZH-3-300	

Outline Dimensions

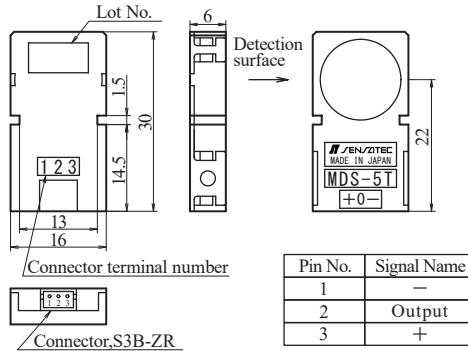

Mounting Bracket (Sold Separately)

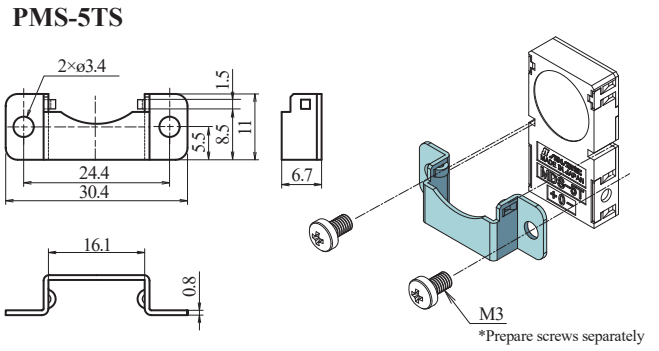

Output Circuit

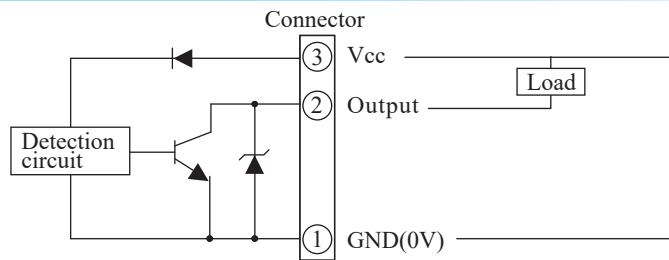

Precautions During Use

- Influence of surrounding metal

If there are metal objects around the inductive sensor, leave at least the space indicated in the figure below between them and the sensor.

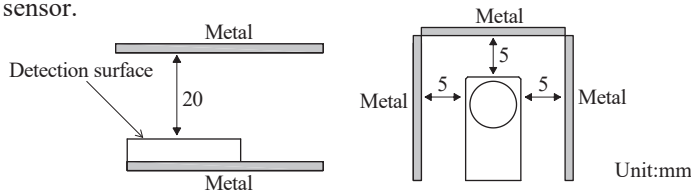

- Mutual interference

If you use a number of the same product, separate them at least by the distances shown in the figure below to prevent reciprocal interference. (Sensors with a different frequency are indicated with a B after the model name.)

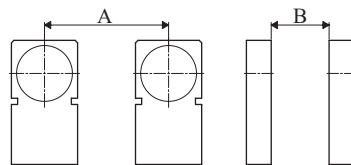

	When they have the same frequency	Combination with different frequencies
A	110	60
B	200	100

Unit:mm

- Mounting

Always use plain washers to tighten the case and use a torque of 0.5 N·m or less.

- See inductive sensor general usage precautions for other precautions.

Characteristics Graph (Typical Example)

Detection area diagram

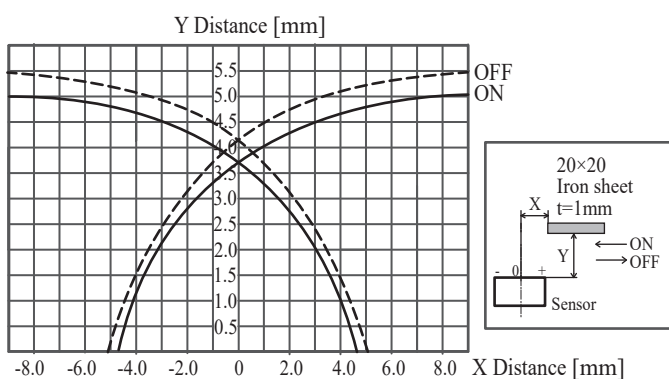

*For a detailed specification of the other, please refer to specifications.

Material and size - Detection distance characteristics

